

# SHELVING

ARTINOX

# INOX LINE

Stainless steel uprights  
Stainless steel shelves

Montanti in acciaio inox  
Ripiani in acciaio inox

Chromnickelstahl Regalständer  
Chromnickelstahl Fachböden

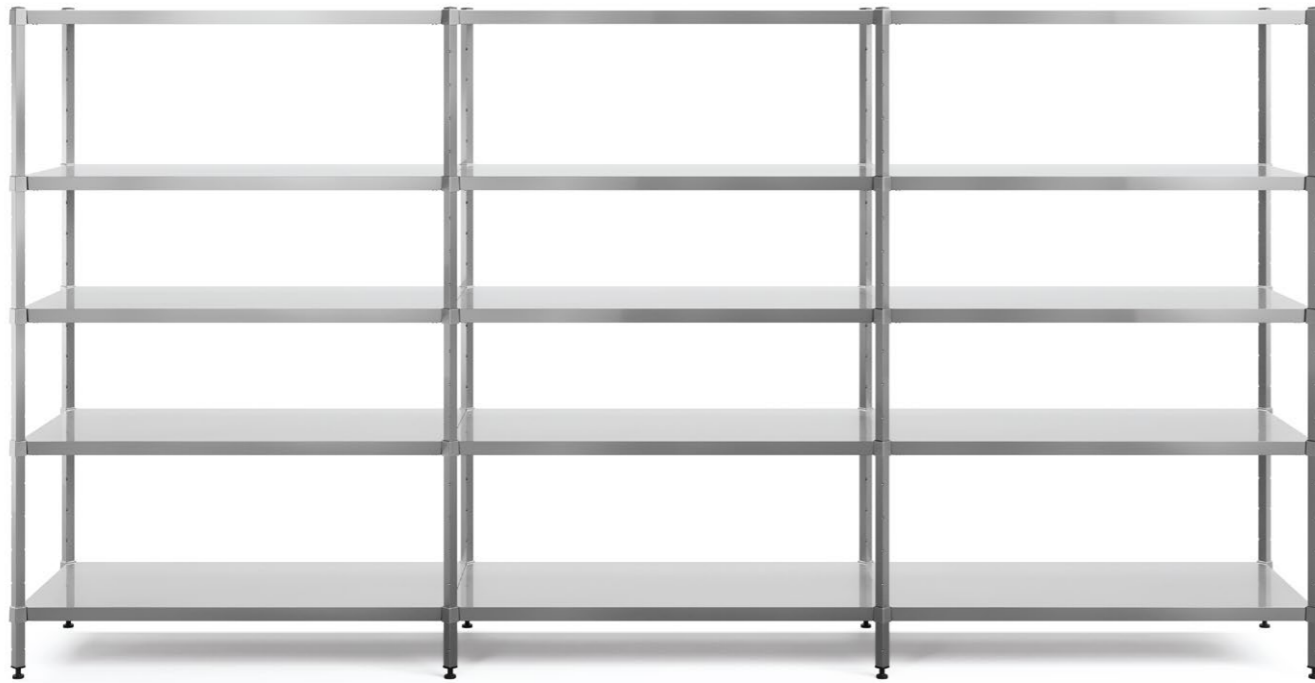

- **HYGIENIC**
- **STURDY**
- **VERSATILE**
- **RESISTANT UP TO -40°C**

- **IGIENICO**
- **ROBUSTO**
- **VERSATILE**
- **RESISTENTE FINO A -40°C**

- **HYGIENISCH**
- **ROBUST**
- **VIELSEITIG**
- **BESTÄNDIG BIS -40°C**

## Quick assembly

IN-FIX®, the patented self-locking fixing system, allows for easy and quick assembly, requiring only one operator, without the use of screws and tools.

Four types of fixing components for: starter shelving units [1], linear [2] or corner compositions [3] and compositions at 180° or 360° [4].

Height adjustable shelves on a 100 mm pitch.



## Montaggio rapido

IN-FIX®, il sistema brevettato ad incastro conico autobloccante, consente un montaggio rapido con un solo operatore, senza viti e utensili.

Quattro tipi di aggancio per: scaffalature singole [1], composizioni diritte [2] o ad angolo [3], composizioni a 180° o 360° [4].

Ripiani regolabili in altezza con passo 100 mm.



## Schnelle Montage

IN-FIX®, das patentierte selbstblockierende Befestigungssystem, erlaubt eine schnelle und praktische Montage, die ohne Schrauben und Werkzeug durchgeführt werden kann.

Vier Halterung Typen für: Grundregale [1], Gerade [2] oder Übereck Kompositionen [3] und 180° oder 360° Kompositionen [4].

Höhenverstellbare Fachböden im 100 mm Raster.

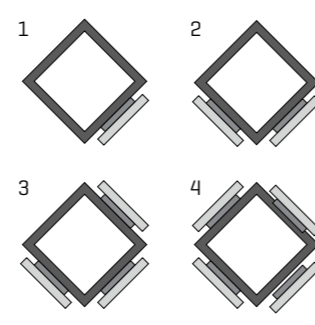

# ECO LINE

Stainless steel  
or powder-coated galvanised steel structure  
Polypropylene shelves

Struttura in acciaio inox  
o in acciaio zincato verniciato a polvere  
Ripiani in polipropilene

Chromnickelstahl  
oder verzinkte pulverbeschichtete Stahlstruktur  
Polypropylen Fachböden



- **HYGIENIC**
- **STURDY**
- **VERSATILE**
- **RESISTANT UP TO -30°C**

- **IGIENICO**
- **ROBUSTO**
- **VERSATILE**
- **RESISTENTE FINO A -30°C**

- **HYGIENISCH**
- **ROBUST**
- **VIELSEITIG**
- **BESTÄNDIG BIS -30°C**

## Quick assembly

IN-FIX®, the patented self-locking fixing system, allows for easy and quick assembly, requiring only one operator, without the use of screws and tools.

Four types of depth bars for: starter shelving units [1], linear [2] or corner compositions [3] and compositions at 180° or 360° [4].

Height adjustable shelves on a 100 mm pitch.



## Montaggio rapido

IN-FIX®, il sistema brevettato ad incastro conico autobloccante, consente un montaggio rapido con un solo operatore, senza viti e utensili.

Quattro tipi di traverse per: scaffalature singole [1], composizioni diritte [2] o ad angolo [3], composizioni a 180° o 360° [4].

Ripiani regolabili in altezza, con passo 100 mm.



## Schnelle Montage

IN-FIX®, das patentierte selbstblockierende Befestigungssystem, erlaubt eine schnelle und praktische Montage, die ohne Schrauben und Werkzeug durchgeführt werden kann.

Vier Typen Tiefequerbalken für: Grundregale [1], Gerade [2] oder Übereck Kompositionen [3] und 180° oder 360° Kompositionen [4].

Höhenverstellbare Fachböden im 100 mm Raster.

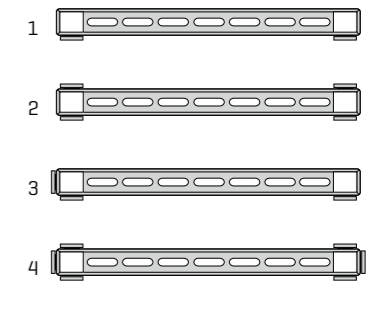

# INOX STANDARD



## STRUCTURE / STRUTTURA / STRUKTUR

**Material / Materiale / Material:**  
AISI 304 stainless steel  
uprights and fixing components /  
Montanti e agganci  
in acciaio inox AISI 304 /  
Regalständer und Halterungen  
aus Chromnickelstahl W 1.4301

**Tube section / Sezione tubo /  
Rohrabschnitt (mm):**  
30 X 30 X 1

**Heights / Altezze / Höhen (mm):**  
1400 - 1600 - 1800 - 2000

## SHELVES / RIPIANI / FACHBÖDEN

**Material / Materiale / Material:**  
AISI 304 stainless steel /  
Acciaio inox AISI 304/  
Chromnickelstahl W 1.4301

**Thickness / Spessore / Dicke (mm):**  
40

**Lengths / Lunghezze / Längen (mm):**  
600 - 700 - 800 - 900 - 1000  
1100 - 1200 - 1300 - 1400 - 1500  
1600 - 1700 - 1800 - 1900 - 2000

**Depths / Profondità / Tiefen (mm):**  
300 - 400 - 500 - 600

## SHELF TYPES / TIPI DI RIPIANO / FACHBÖDEN TYPEN

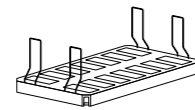
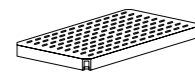
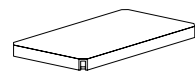

Smooth shelves  
Ripiani lisci  
Glatte Fachböden

Perforated shelves  
Ripiani forati  
Gelochte Fachböden

Bottle shelves  
Ripiani portabottiglie  
Flaschen-Fachböden

## LOAD CAPACITY / CAPACITÀ DI CARICO / TRAGFÄHIGKEIT

Shelf length / Lunghezza ripiano / Regalbreiten	Kg*
600 > 1000 mm	200
1100 > 1500 mm	150
1600 > 2000 mm	100

\*  
Load capacity per shelf with evenly distributed weight  
Portate per ripiano con distribuzione uniforme del carico  
Tragfähigkeit pro Boden bei gleichmäßiger Verteilung der Last

**Total load / Carico totale / Gesamtbelastung:**

**MAX 800 KG**

## ACCESSORIES AND COMPLEMENTS / ACCESSORI E COMPLEMENTI / ZUBEHÖRTEILE UND KOMPLEMENTE

- Fixing components to floor, ceiling, wall  
Fissaggi a pavimento, soffitto, muro  
Boden-, Decken-, Wandbefestigungen
- Stainless steel back panels  
Lamiera di tamponamento in acciaio inox  
Rückwände aus Chromnickelstahl
- Stainless steel anti-roll bars  
Barre anti-rollo in acciaio inox  
Antirollstangen aus Chromnickelstahl
- Load distribution plates  
Piastrine di distribuzione peso al suolo  
Bodendruckverteilungsplatten
- Stainless steel swivelling castors  
Ruote girevoli in acciaio inox  
Drehbare Räder aus Chromnickelstahl

# INOX PLUS



## STRUCTURE / STRUTTURA / STRUKTUR

**Material / Materiale / Material:**  
AISI 304 stainless steel  
uprights and fixing components /  
Montanti e agganci  
in acciaio inox AISI 304 /  
Regalständer und Halterungen  
aus Chromnickelstahl W 1.4301

**Tube section / Sezione tubo /  
Rohrabschnitt (mm):**  
40 X 40 X 1.2

**Heights / Altezze / Höhen (mm):**  
1400 - 1600 - 1800 - 2000

## SHELVES / RIPIANI / FACHBÖDEN

**Material / Materiale / Material:**  
AISI 304 stainless steel /  
Acciaio inox AISI 304/  
Chromnickelstahl W 1.4301

**Thickness / Spessore / Dicke (mm):**  
50

**Lengths / Lunghezze / Längen (mm):**  
600 - 700 - 800 - 900 - 1000  
1100 - 1200 - 1300 - 1400 - 1500  
1600 - 1700 - 1800 - 1900 - 2000

**Depths / Profondità / Tiefen (mm):**  
300 - 400 - 500 - 600

## SHELF TYPES / TIPI DI RIPIANO / FACHBÖDEN TYPEN

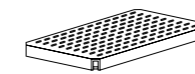
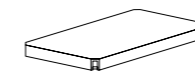

Smooth shelves  
Ripiani lisci  
Glatte Fachböden

Perforated shelves  
Ripiani forati  
Gelochte Fachböden

## LOAD CAPACITY / CAPACITÀ DI CARICO / TRAGFÄHIGKEIT

Shelf length / Lunghezza ripiano / Regalbreiten	Kg*
600 > 1000 mm	350
1100 > 1500 mm	300
1600 > 2000 mm	200

\*  
Load capacity per shelf with evenly distributed weight  
Portate per ripiano con distribuzione uniforme del carico  
Tragfähigkeit pro Boden bei gleichmäßiger Verteilung der Last

**Total load / Carico totale / Gesamtbelastung:**

**MAX 1200 KG**

## ACCESSORIES AND COMPLEMENTS / ACCESSORI E COMPLEMENTI / ZUBEHÖRTEILE UND KOMPLEMENTE

- Fixing components to floor, ceiling, wall  
Fissaggi a pavimento, soffitto, muro  
Boden-, Decken-, Wandbefestigungen
- Stainless steel back panels  
Lamiera di tamponamento in acciaio inox  
Rückwände aus Chromnickelstahl
- Stainless steel anti-roll bars  
Barre anti-rollo in acciaio inox  
Antirollstangen aus Chromnickelstahl
- Load distribution plates  
Piastrine di distribuzione peso al suolo  
Bodendruckverteilungsplatten
- Stainless steel swivelling castors  
Ruote girevoli in acciaio inox  
Drehbare Räder aus Chromnickelstahl

# ECO INOX



## STRUCTURE / STRUTTURA / STRUKTUR

### Materials / Materiali / Materialien:

AISI 304 stainless steel structure, polypropylene depth bars /  
Struttura in acciaio inox AISI 304, traverse in polipropilene /  
Chromnickelstahl W 1.4301 Struktur, Polypropylen Tiefequerbalken

### Tube section / Sezione tubo / Rohrschnitt (mm):

30 X 30 X 1

### Depths / Profondità / Tiefen (mm):

300 - 400 - 500 - 600

### Heights / Altezze / Höhen (mm):

1400 - 1600 - 1800 - 2000

## SHELVES / RIPIANI / FACHBÖDEN

### Materials / Materiali / Materialien:

Polypropylene or AISI 304 stainless steel /  
Polipropilene o acciaio inox AISI 304 /  
Polypropylen oder Chromnickelstahl W 1.4301

### Thickness / Spessore / Dicke (mm):

40

### Lengths / Lunghezza / Längen (mm):

600 - 700 - 800 - 900 - 1000

1100 - 1200 - 1300 - 1400 - 1500

1600 - 1700 - 1800 - 1900 - 2000

### Depths / Profondità / Tiefen (mm):

300 - 400 - 500 - 600

## SHELF TYPES / TIPI DI RIPIANO / FACHBÖDEN TYPEN

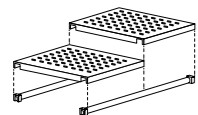

Dishwasher safe polypropylene shelves

Ripiani in polipropilene lavabili in lavastoviglie

Spülmaschinenfest Polypropylen Fachböden

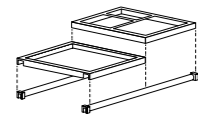

Stainless steel holders for GN containers

Supporti in acciaio inox per contenitori GN

Chromnickelstahl Halter für GN Behälter

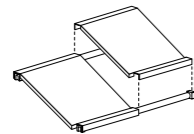

Stainless steel inclined shelves

Ripiani inclinati in acciaio inox

Chromnickelstahl Schrägböden

## LOAD CAPACITY / CAPACITÀ DI CARICO / TRAGFÄHIGKEIT

Shelf length / Lunghezza ripiano / Regalbreiten	Kg*
600 > 1000 mm	250
1100 > 1500 mm	200
1600 > 2000 mm	150

\* Load capacity per shelf with evenly distributed weight  
Portate per ripiano con distribuzione uniforme del carico  
Tragfähigkeit pro Boden bei gleichmäßiger Verteilung der Last

### Total load / Carico totale / Gesamtbelastung:

**MAX 1000 KG**

## ACCESSORIES AND COMPLEMENTS / ACCESSORI E COMPLEMENTI / ZUBEHÖRTEILE UND KOMPLEMENTE

- Fixing components to floor, ceiling, wall  
Fissaggi a pavimento, soffitto, muro  
Boden-, Decken-, Wandbefestigungen
- Stainless steel back panels  
Lamiera di tamponamento in acciaio inox  
Rückwände aus Chromnickelstahl
- Stainless steel anti-roll bars  
Barre anti-rollo in acciaio inox  
Antirollstangen aus Chromnickelstahl
- Load distribution plates  
Piastrine di distribuzione peso al suolo  
Bodendruckverteilungsplatten
- Stainless steel swivelling castors  
Ruote girevoli in acciaio inox  
Drehbare Räder aus Chromnickelstahl
- Meat hangers and platforms  
Ganciere e pedane  
Fleischgehänge und Bodenröste

# ECO COLOR



## STRUCTURE / STRUTTURA / STRUKTUR

### Materials / Materiali / Materialien:

Powder-coated galvanized steel structure, polypropylene depth bars /  
Struttura in acciaio zincato verniciato a polvere, traversi in polipropilene /  
Verzinkte pulverbeschichtete Stahlstruktur, Polypropylen Tiefequerbalken

### Tube section / Sezione tubo / Rohrschnitt (mm):

30 X 30 X 1

### Depths / Profondità / Tiefen (mm):

300 - 400 - 500 - 600

### Heights / Altezze / Höhen (mm):

1400 - 1600 - 1800 - 2000

## SHELVES / RIPIANI / FACHBÖDEN

### Material / Materiale / Material:

Polypropylene / Polipropilene / Polypropylen

### Thickness / Spessore / Dicke (mm):

40

### Lengths / Lunghezza / Längen (mm):

600 - 700 - 800 - 900 - 1000

1100 - 1200 - 1300 - 1400 - 1500

1600 - 1700 - 1800 - 1900 - 2000

### Depths / Profondità / Tiefen (mm):

300 - 400 - 500 - 600

## SHELF TYPES / TIPI DI RIPIANO / FACHBÖDEN TYPEN

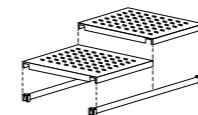

Dishwasher safe polypropylene shelves

Ripiani in polipropilene lavabili in lavastoviglie

Spülmaschinenfest Polypropylen Fachböden

## LOAD CAPACITY / CAPACITÀ DI CARICO / TRAGFÄHIGKEIT

Shelf length / Lunghezza ripiano / Regalbreiten	Kg*
600 > 1000 mm	250
1100 > 1500 mm	200
1600 > 2000 mm	150

\* Load capacity per shelf with evenly distributed weight  
Portate per ripiano con distribuzione uniforme del carico  
Tragfähigkeit pro Boden bei gleichmäßiger Verteilung der Last

### Total load / Carico totale / Gesamtbelastung:

**MAX 1000 KG**

## ACCESSORIES AND COMPLEMENTS / ACCESSORI E COMPLEMENTI / ZUBEHÖRTEILE UND KOMPLEMENTE

- Fixing components to floor, ceiling, wall  
Fissaggi a pavimento, soffitto, muro  
Boden-, Decken-, Wandbefestigungen
- Load distribution plates  
Piastrine di distribuzione peso al suolo  
Bodendruckverteilungsplatten
- Stainless steel swivelling castors  
Ruote girevoli in acciaio inox  
Drehbare Räder aus Chromnickelstahl

## ARTINOX SHELVING

Ideal for horeca, retail, agri-food, hospital, chemical, pharmaceutical and naval sectors.

## SCAFFALATURE ARTINOX

Ideali per i settori horeca, gdo, agroalimentare, ospedaliero, chimico, farmaceutico e navale.

## ARTINOX-REGALE

Speziell geeignet für Horeca, Supermarkt, Lebensmittel-, Chemie-, Pharma - und Schiffbau-Bereichen.

---

### ARTINOX spa

Via F. Fabbrì, 39 - z.i. Campidui  
 31015 Conegliano (Treviso) - Italy  
 Tel. +39 0438 4531 - Fax +39 0438 453200  
 shelving@artinox.com  
 www.artinox-shelving.com



Our products are eco friendly  
 with 100% recyclable materials.

I nostri prodotti rispettano l'ambiente  
 con materiali riciclabili al 100%.

Unsere Produkte sind umweltfreundlich  
 mit Materialien zu 100 % rezyklierbar.



The NF "Hygiène Alimentaire" mark, issued  
 by ANFOR Certification, certifies the compliance  
 with the NF031 specific rules, available on  
[www.marque-nf.com](http://www.marque-nf.com), for the cleaning aptitude.